

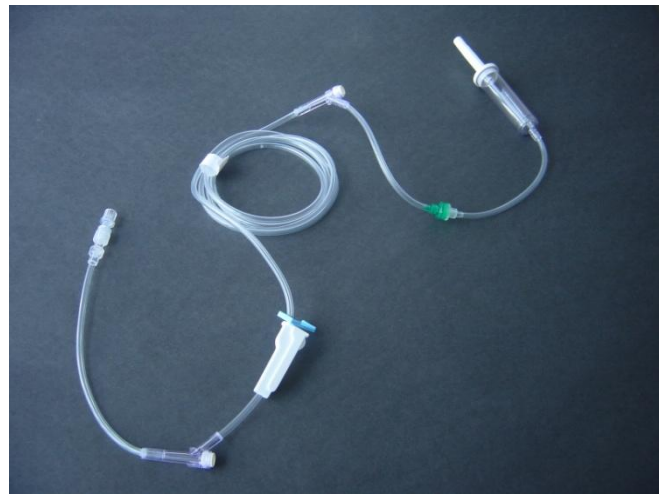

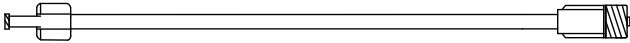

MEDIONICS INTERNATIONAL INC.

INFUSION PRODUCTS AND ACCESS DEVICES CATALOGUE

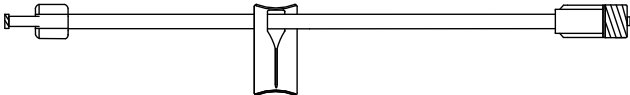
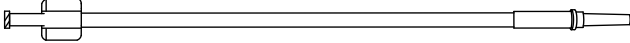
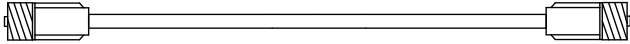

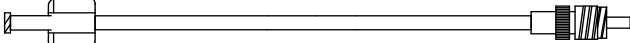
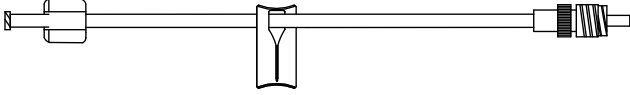
Product Illustration	Description & Catalogue Number
Extension Sets Standardbore	
	<p>Extension Set, standard bore, FLL/MLL</p> <p><i>ES-MF05 – length 5"</i> <i>ES-MF30 – length 30"</i> <i>ES-MF10 – length 10"</i> <i>ES-MF40 – length 40"</i> <i>ES-MF15 – length 15"</i> <i>ES-MF50 – length 50"</i> <i>ES-MF20 – length 20"</i> <i>ES-MF60 – length 60"</i></p>
	<p>Extension Set, standard bore, FLL/MLL, slide clamp</p> <p><i>ES-MF05S – length 5"</i> <i>ES-MF30S – length 30"</i> <i>ES-MF10S – length 10"</i> <i>ES-MF40S – length 40"</i> <i>ES-MF15S – length 15"</i> <i>ES-MF50S – length 50"</i> <i>ES-MF20S – length 20"</i> <i>ES-MF60S – length 60"</i></p>
	<p>Extension Set, standard bore, FLL/MLS (male luer slip)</p> <p><i>ES-MSF05 – length 5"</i> <i>ES-MSF30 – length 30"</i> <i>ES-MSF10 – length 10"</i> <i>ES-MSF40 – length 40"</i> <i>ES-MSF15 – length 15"</i> <i>ES-MSF50 – length 50"</i> <i>ES-MSF20 – length 20"</i> <i>ES-MSF60 – length 60"</i></p>
	<p>Extension Set, standard bore, MLL/MLL</p> <p><i>ES-MM05 – length 5"</i> <i>ES-MM30 – length 30"</i> <i>ES-MM10 – length 10"</i> <i>ES-MM40 – length 40"</i> <i>ES-MM15 – length 15"</i> <i>ES-MM50 – length 50"</i> <i>ES-MM20 – length 20"</i> <i>ES-MM60 – length 60"</i></p>
	<p>Extension Set, standard bore, MLL/MLL, slide clamp</p> <p><i>ES-MM05P – length 5"</i> <i>ES-MM30P – length 30"</i> <i>ES-MM10P – length 10"</i> <i>ES-MM40P – length 40"</i> <i>ES-MM15P – length 15"</i> <i>ES-MM50P – length 50"</i> <i>ES-MM20P – length 20"</i> <i>ES-MM60P – length 60"</i></p>
	<p>Extension Set, standard bore, rotating MLL/FLL</p> <p><i>ES-MRF05 – length 5"</i> <i>ES-MRF30 – length 30"</i> <i>ES-MRF10 – length 10"</i> <i>ES-MRF40 – length 40"</i> <i>ES-MRF15 – length 15"</i> <i>ES-MRF50 – length 50"</i> <i>ES-MRF20 – length 20"</i> <i>ES-MRF60 – length 60"</i></p>
	<p>Extension Set, standard bore, rotating MLL/FLL, slide clamp</p> <p><i>ES-MRF05S – length 5"</i> <i>ES-MRF30S – length 30"</i> <i>ES-MRF10S – length 10"</i> <i>ES-MRF40S – length 40"</i> <i>ES-MRF15S – length 15"</i> <i>ES-MRF50S – length 50"</i> <i>ES-MRF20S – length 20"</i> <i>ES-MRF60S – length 60"</i></p>
	<p>Extension Set, standard bore, rotating MLL/FLL, roller clamp</p> <p><i>ES-MRF15RC – length 15"</i> <i>ES-MRF40RC – length 40"</i> <i>ES-MRF20RC – length 20"</i> <i>ES-MRF50RC – length 50"</i> <i>ES-MRF30RC – length 30"</i> <i>ES-MRF60RC – length 60"</i></p>

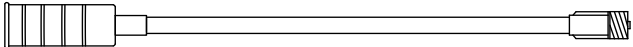
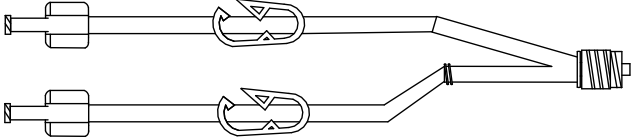
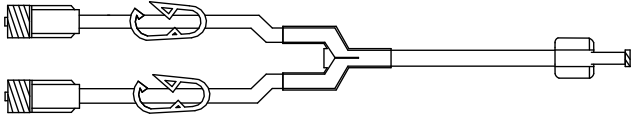
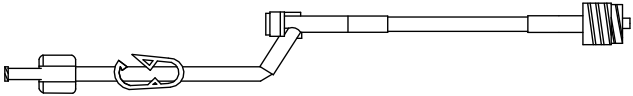
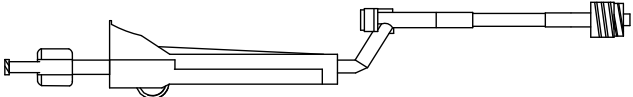
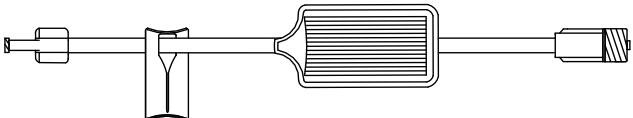
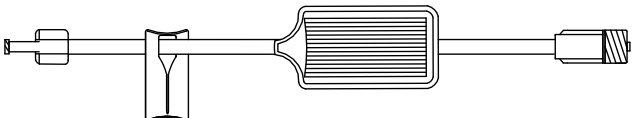
	<p>Extension Set, standard bore, 15", Funnel Connector/MLL</p> <p><i>ES-FCM15 – length 15"</i></p>
	<p>Y Extension Set, standard bore, 4", FLL/ Rotating Male Luer Lock</p> <p><i>ES-MRFY4 – length 4"</i></p>
	<p>Y Extension Set, standard bore, 125", MLL/ FLL</p> <p><i>ES-MFY125 – length 125"</i></p>
	<p>Extension Set, standard bore, 8", with Latex Free Injection Site, on/off clamp</p> <p><i>ES-MFY8 – length 8"</i></p>
	<p>Extension Set, standard bore, 180", with Latex Free Injection Site</p> <p><i>ES-MFY180RC – length 180"</i></p>
	<p>Extension Set, standard bore, FLL/MLL, 0.2 micron air eliminating filter, slide clamp</p> <p><i>ES-MF15S2 – length 15"</i> <i>ES-MF40S2 – length 40"</i> <i>ES-MF20S2 – length 20"</i> <i>ES-MF50S2 – length 50"</i> <i>ES-MF30S2 – length 30"</i> <i>ES-MF60S2 – length 60"</i></p>
	<p>Extension Set, standard bore, FLL/MLL, 1.2 micron air eliminating filter, slide clamp</p> <p><i>ES-MF15S12 – length 15"</i> <i>ES-MF40S12 – length 40"</i> <i>ES-MF20S12 – length 20"</i> <i>ES-MF50S12 – length 50"</i> <i>ES-MF30S12 – length 30"</i> <i>ES-MF60S12 – length 60"</i></p>

Extension Sets Standardbore w/ Check Valve

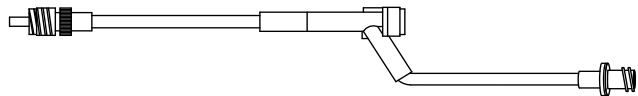
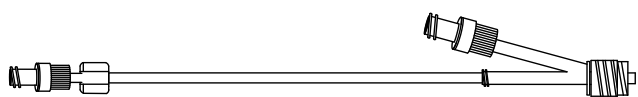
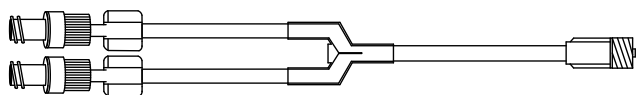
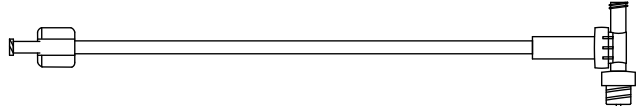
 <p style="text-align: right;"><i>Check Valve</i></p>	<p>Extension Set, standard bore, 10", with Latex Free Injection Site, input check valve</p> <p><i>ES-MRFYCV10 – length 10"</i></p>
	<p>Y Extension Set, standard bore, 10", Pressure Check Valve at both inputs, Rotating Male Luer Lock output, for use in CT scan and MRI</p> <p><i>ES-CV2Y10 – length 10"</i></p>
	<p>Y Extension Set, standard bore, 12", Pressure Check Valve inputs, Male Luer Lock output, for use in CT scan and MRI</p> <p><i>ES-CV2Y12 – length 12"</i></p>
 <p style="text-align: right;"><i>Dual Check Valve</i></p>	<p>Extension Set, standard bore, FLL/ Dual Pressure Check Valve, for automatic filling of syringes, in CT scan and MRI</p> <p><i>ES-DCVF6 – length 6"</i></p>

Extension Sets Standardbore w/ Needleless Luer Activated Valve

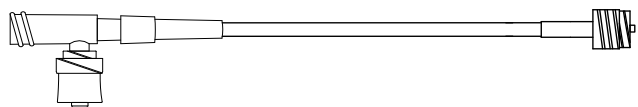
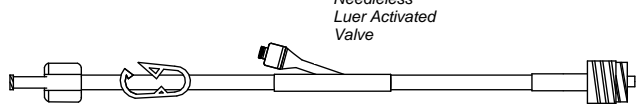
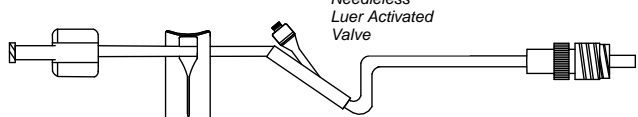
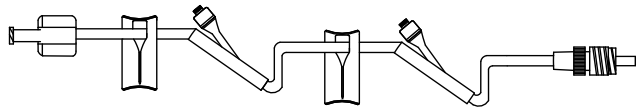
	<p>Extension Set, standard bore, MLL/FLL with needleless luer activated "T" valve</p> <p><i>ES-MFNT72 – length 72"</i></p> <div style="border: 1px solid black; padding: 5px; width: fit-content; margin-left: auto;"> <p><i>ES-MFNTxx (xx is length in inches)</i></p> </div>
 <p style="text-align: center;"><i>Needleless Luer Activated Valve</i></p>	<p>Extension Set, standard bore, 8", one needleless luer activated valve , on/off clamp</p> <p><i>ES-MFNY8 – length 8"</i></p> <div style="border: 1px solid black; padding: 5px; width: fit-content; margin-left: auto;"> <p><i>ES-MFNYxx (xx is length in inches)</i></p> </div>
 <p style="text-align: center;"><i>Needleless Luer Activated Valve</i></p>	<p>Extension Set, standard bore, 14", one needleless luer activated valve, rotating MLL, slide clamp</p> <p><i>ES-MRFNY14 – length 14"</i></p> <div style="border: 1px solid black; padding: 5px; width: fit-content; margin-left: auto;"> <p><i>ES-MRFNYxx (xx is length in inches)</i></p> </div>
 <p style="text-align: center;"><i>Needleless Luer Activated Valve</i> <i>Needleless Luer Activated Valve</i></p>	<p>Extension Set, standard bore, 42", two needleless luer activated valves, rotating MLL, slide clamps</p> <p><i>ES-MRFNY242 – length 42"</i></p> <div style="border: 1px solid black; padding: 5px; width: fit-content; margin-left: auto;"> <p><i>ES-MRFNY2xx (xx is length in inches)</i></p> </div>

Extension Sets Standardbore w/ Stopcock

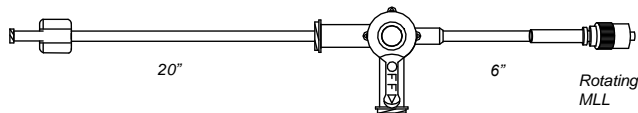

Extension Set, standard bore, 3 way stopcock with "OFF" Handle, rotating MLL

ES-W3F28 – length 28"

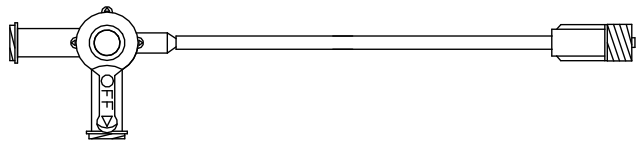

Extension Set, standard bore, 3 way stopcock with "OFF" Handle, MLL

ES-W3F10M – length 10" ES-W3F40M – length 40"
 ES-W3F20M – length 20" ES-W3F50M – length 50"
 ES-W3F30M – length 30" ES-W3F60M – length 60"

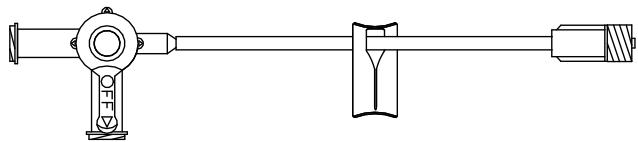

Extension Set, standard bore, 3 way stopcock with "OFF" Handle, MLL, slide clamp

ES-W3F10MS – length 10" ES-W3F40MS – length 40"
 ES-W3F20MS – length 20" ES-W3F50MS – length 50"
 ES-W3F30MS – length 30" ES-W3F60MS – length 60"

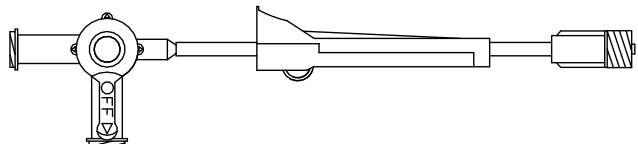

Extension Set, standard bore, 3 way stopcock with "OFF" Handle, MLL, roller clamp

ES-W3F10MRC – length 10" ES-W3F40MRC – length 40"
 ES-W3F20MRC – length 20" ES-W3F50MRC – length 50"
 ES-W3F30MRC – length 30" ES-W3F60MRC – length 60"

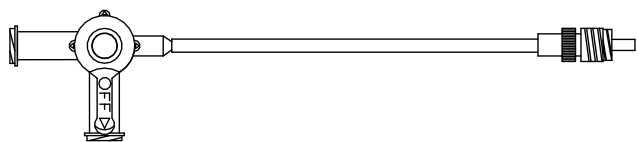

Extension Set, standard bore, 3 way stopcock with "OFF" Handle, rotating MLL, no slide clamp

ES-W3F10MR – length 10" ES-W3F40MR – length 40"
 ES-W3F20MR – length 20" ES-W3F50MR – length 50"
 ES-W3F30MR – length 30" ES-W3F60MR – length 60"

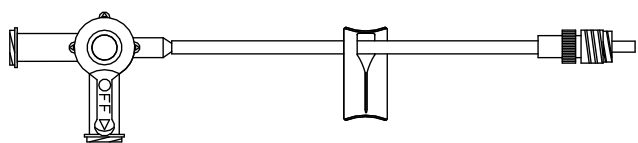

Extension Set, standard bore, 3 way stopcock with "OFF" Handle, rotating MLL, slide clamp

ES-W3F10MRS – length 10" ES-W3F40MRS – length 40"
 ES-W3F20MRS – length 20" ES-W3F50MRS – length 50"
 ES-W3F30MRS – length 30" ES-W3F60MRS – length 60"

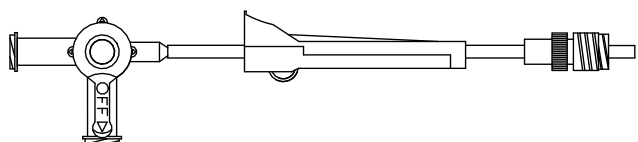

Extension Set, standard bore, 3 way stopcock with "OFF" Handle, rotating MLL, roller clamp

ES-W3F10MRRC – length 10" ES-W3F40MRRC – length 40"
 ES-W3F20MRRC – length 20" ES-W3F50MRRC – length 50"
 ES-W3F30MRRC – length 30" ES-W3F60MRRC – length 60"

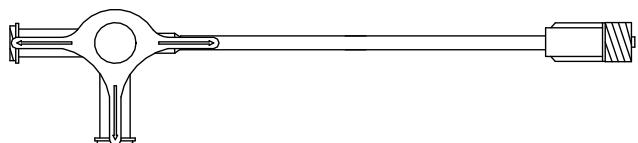

Extension Set, standard bore, 4 way stopcock with "T" Handle, MLL

ES-W4T10M – length 10" ES-W4T40M – length 40"
 ES-W4T20M – length 20" ES-W4T50M – length 50"
 ES-W4T30M – length 30" ES-W4T60M – length 60"

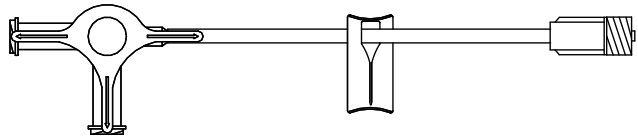
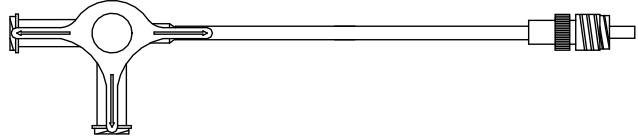
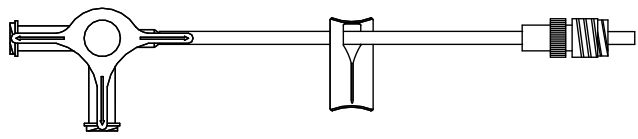
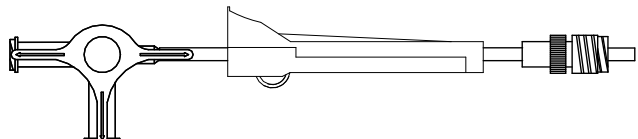
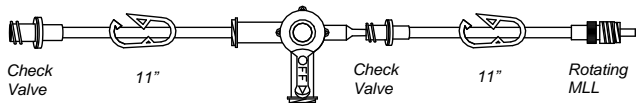
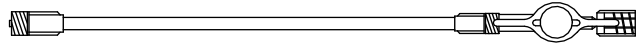
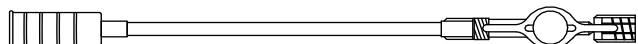
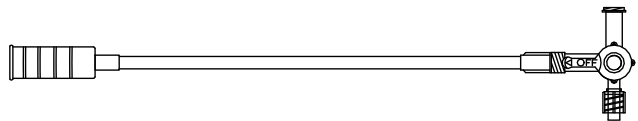
	<p>Extension Set, standard bore, 4 way stopcock with "T" Handle, MLL, slide clamp</p> <p><i>ES-W4T10MS – length 10"</i> <i>ES-W4T40MS – length 40"</i> <i>ES-W4T20MS – length 20"</i> <i>ES-W4T50MS – length 50"</i> <i>ES-W4T30MS – length 30"</i> <i>ES-W4T60MS – length 60"</i></p>
	<p>Extension Set, standard bore, 4 way stopcock with "T" Handle, rotating MLL</p> <p><i>ES-W4T10MR – length 10"</i> <i>ES-W4T40MR – length 40"</i> <i>ES-W4T20MR – length 20"</i> <i>ES-W4T50MR – length 50"</i> <i>ES-W4T30MR – length 30"</i> <i>ES-W4T60MR – length 60"</i></p>
	<p>Extension Set, standard bore, 4 way stopcock with "T" Handle, rotating MLL, slide clamp</p> <p><i>ES-W4T10MRS – length 10"</i> <i>ES-W4T40MRS – length 40"</i> <i>ES-W4T20MRS – length 20"</i> <i>ES-W4T50MRS – length 50"</i> <i>ES-W4T30MRS – length 30"</i> <i>ES-W4T60MRS – length 60"</i></p>
	<p>Extension Set, standard bore, 4 way stopcock with "T" Handle, rotating MLL, roller clamp</p> <p><i>ES-W4T10MRRC – length 10"</i> <i>ES-W4T40MRRC – length 40"</i> <i>ES-W4T20MRRC – length 20"</i> <i>ES-W4T50MRRC – length 50"</i> <i>ES-W4T30MRRC – length 30"</i> <i>ES-W4T60MRRC – length 60"</i></p>
 <p>Check Valve 11" Check Valve 11" Rotating MLL</p>	<p>Extension Set, standard bore, 3 way stopcock with "OFF" Handle, rotating MLL, two check valves to ensure way flow</p> <p><i>ES-W3F24CV2 – length 24"</i></p>
	<p>Connecting Tube, 12", with MLL connector, 1 way stopcock w/ rotating MLL</p> <p><i>ES-W1F12M – length 12"</i></p>
	<p>Connecting Tube, 12", with Funnel connector, 1 way stopcock w/ rotating MLL</p> <p><i>ES-W1F12FC – length 12"</i></p>
	<p>Connecting Tube, 12", with Funnel connector, 3 way stopcock w/ rotating MLL</p> <p><i>ES-W3F12FC – length 12"</i></p>

Extension Sets Minibore



Extension Set, minibore, FLL/MLL

- ESM-MF05 – length 5"*
- ESM-MF10 – length 10"*
- ESM-MF15 – length 15"*
- ESM-MF20 – length 20"*
- ESM-MF30 – length 30"*
- EMS-MF40 – length 40"*
- EMS-MF50 – length 50"*
- EMS-MF60 – length 60"*



Extension Set, minibore, FLL/MLL, anesthesia tubing with yellow stripe for identification

- ESM-MF40YS – length 40"*
- ESM-MF50YS – length 50"*
- EMS-MF60YS – length 60"*
- EMS-MF70YS – length 70"*

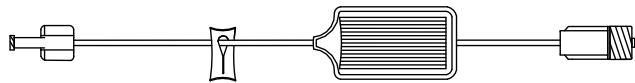

Extension Set, minibore, FLL/MLL, 0.2 micron air eliminating filter, slide clamp

- ESM-MF15S2 – length 15"*
- ESM-MF20S2 – length 20"*
- ESM-MF30S2 – length 30"*
- ESM-MF40S2 – length 40"*
- ESM-MF50S2 – length 50"*
- ESM-MF60S2 – length 60"*

Extension Sets Minibore w/ Needleless Luer Activated Valve

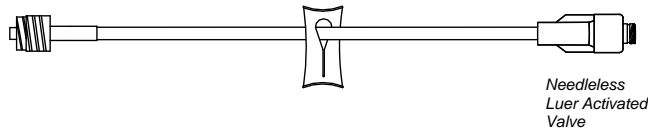

Catheter Extension Set, minibore, needleless luer activated valve, MLL, slide clamp

- ES-6N – length 6"*
- ES-14N – length 14"*
- ES-30N – length 30"*

*ES-xxN
(xx is length in inches)*

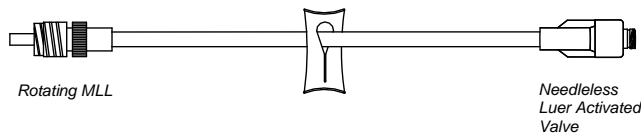

Catheter Extension Set, minibore, needleless luer activated valve, rotating MLL, slide clamp

- ES-6NR – length 6"*
- ES-14NR – length 14"*
- ES-30NR – length 30"*

*ES-xxNR
(xx is length in inches)*

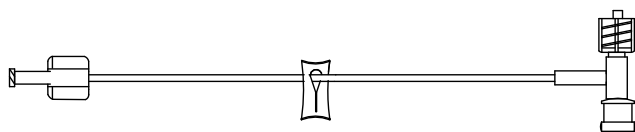

Extension Set, 6", minibore, T connector with rotating MLL, injection site

- ES2-T6 – length 6"*

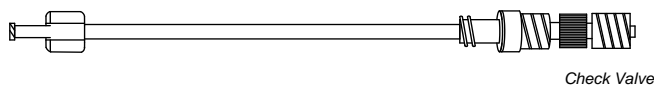

Extension Sets Minibore w/ Check Valve



Extension Set, minibore, 60", pressure check valve at the output end, 500 psi, for CT scan & MRI

- ES-CV60*

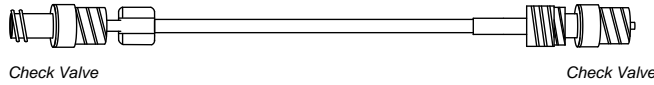
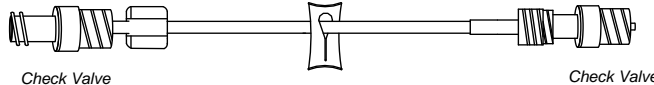
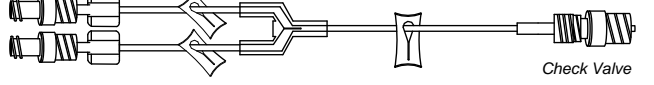
*ES-CVxx
(xx is length in inches)*

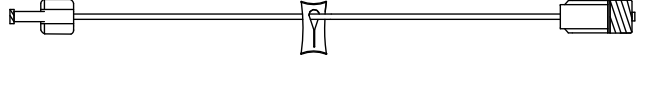

 <p>Check Valve Check Valve</p>	<p>Extension Set, minibore, 60", pressure check valve at both input and output end, 500 psi, for CT scan & MRI</p> <p>ES-CV260</p> <div style="border: 1px solid black; padding: 5px; width: fit-content; margin-left: auto; margin-right: auto;"> <p>ES-CV2xx (xx is length in inches)</p> </div>
 <p>Check Valve Check Valve</p>	<p>Extension Set, minibore, 60" with slide clamp, pressure check valve at both input and output end, 500 psi, for CT scan & MRI</p> <p>ES-CV260S</p> <div style="border: 1px solid black; padding: 5px; width: fit-content; margin-left: auto; margin-right: auto;"> <p>ES-CV2xxS (xx is length in inches)</p> </div>
 <p>Check Valves Check Valve</p>	<p>Y Extension Set, minibore, 70", pressure check valve at both input and output end, for CT scan and MRI</p> <p>ES-CV3YS – length 70"</p>
 <p>Gravity Check Valve</p>	<p>Extension Set, minibore, MLL/MLL, with antisiphon valve, for medication pumps</p> <p>ES-CVG30 – length 30" ES-CVG60 – length 60"</p>

Extension Sets Microbore



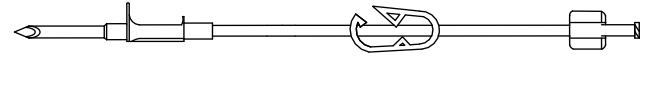
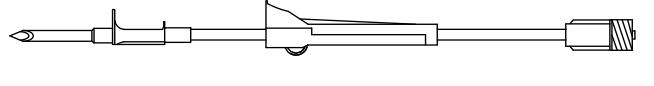
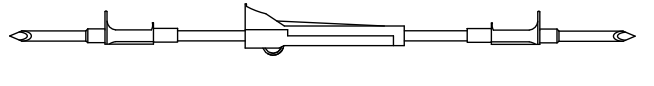

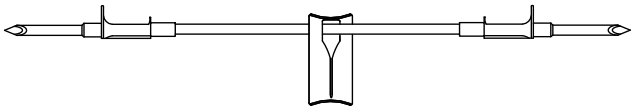
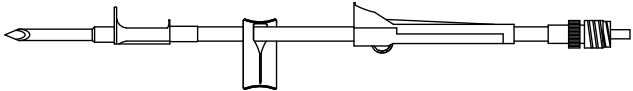
	<p>Extension Set, microbore, FLL/MLL</p> <table style="width: 100%; border: none;"> <tr> <td style="border: none;">ESMB-MF05 – length 5"</td> <td style="border: none;">ESMB-MF30 – length 30"</td> </tr> <tr> <td style="border: none;">ESMB-MF10 – length 10"</td> <td style="border: none;">ESMB-MF40 – length 40"</td> </tr> <tr> <td style="border: none;">ESMB-MF15 – length 15"</td> <td style="border: none;">ESMB-MF50 – length 50"</td> </tr> <tr> <td style="border: none;">ESMB-MF20 – length 20"</td> <td style="border: none;">ESMB-MF60 – length 60"</td> </tr> </table>	ESMB-MF05 – length 5"	ESMB-MF30 – length 30"	ESMB-MF10 – length 10"	ESMB-MF40 – length 40"	ESMB-MF15 – length 15"	ESMB-MF50 – length 50"	ESMB-MF20 – length 20"	ESMB-MF60 – length 60"
ESMB-MF05 – length 5"	ESMB-MF30 – length 30"								
ESMB-MF10 – length 10"	ESMB-MF40 – length 40"								
ESMB-MF15 – length 15"	ESMB-MF50 – length 50"								
ESMB-MF20 – length 20"	ESMB-MF60 – length 60"								

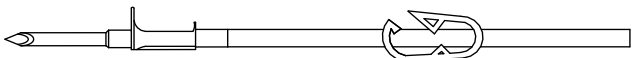
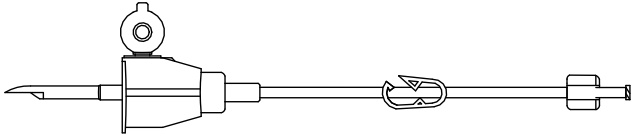
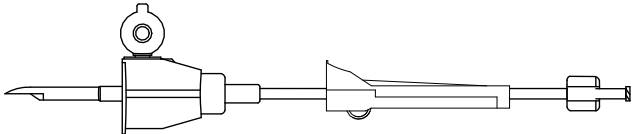
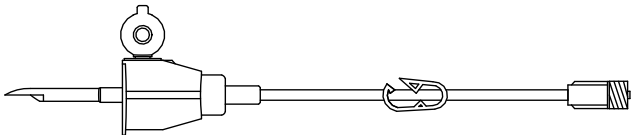
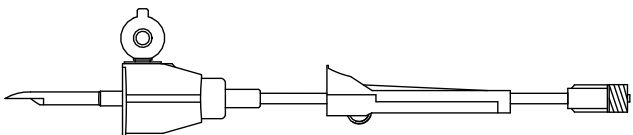

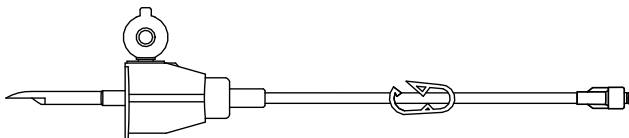
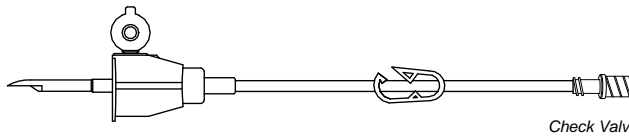
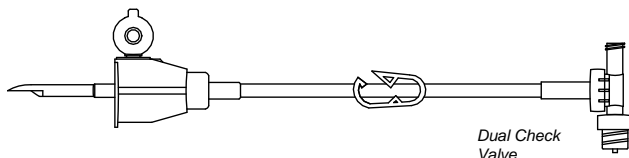
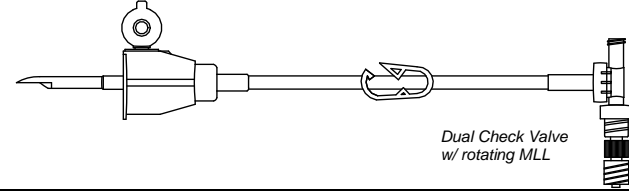
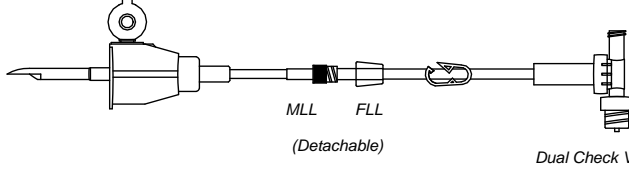
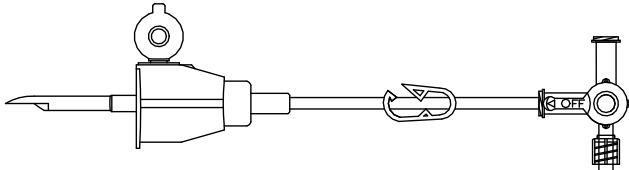
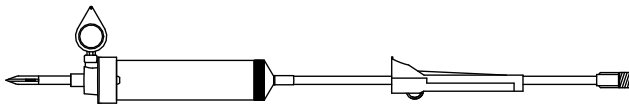
Transfer Sets Standardbore

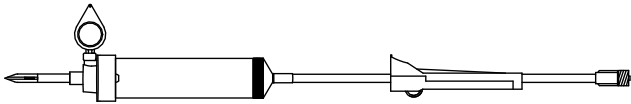
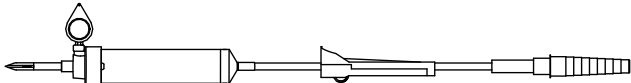
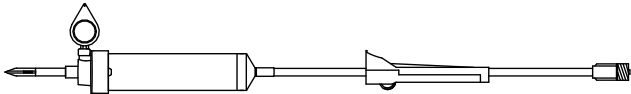
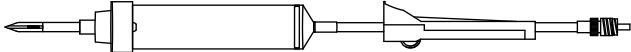
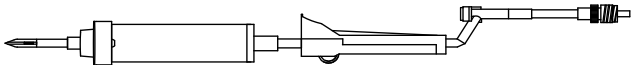
	<p>Transfer Set, standard bore, SPIKE/FLL, on/off clamp</p> <table style="width: 100%; border: none;"> <tr> <td style="border: none;">TS-SF05 – length 5"</td> <td style="border: none;">TS-SF30 – length 30"</td> </tr> <tr> <td style="border: none;">TS-SF10 – length 10"</td> <td style="border: none;">TS-SF40 – length 40"</td> </tr> <tr> <td style="border: none;">TS-SF15 – length 15"</td> <td style="border: none;">TS-SF50 – length 50"</td> </tr> <tr> <td style="border: none;">TS-SF20 – length 20"</td> <td style="border: none;">TS-SF60 – length 60"</td> </tr> </table>	TS-SF05 – length 5"	TS-SF30 – length 30"	TS-SF10 – length 10"	TS-SF40 – length 40"	TS-SF15 – length 15"	TS-SF50 – length 50"	TS-SF20 – length 20"	TS-SF60 – length 60"
TS-SF05 – length 5"	TS-SF30 – length 30"								
TS-SF10 – length 10"	TS-SF40 – length 40"								
TS-SF15 – length 15"	TS-SF50 – length 50"								
TS-SF20 – length 20"	TS-SF60 – length 60"								
	<p>Transfer Set, standard bore, SPIKE/MLL, roller clamp</p> <table style="width: 100%; border: none;"> <tr> <td style="border: none;">TS-SM20R – length 20"</td> <td style="border: none;">TS-SM40R – length 40"</td> </tr> <tr> <td style="border: none;">TS-SM30R – length 30"</td> <td style="border: none;">TS-SM60R – length 60"</td> </tr> </table>	TS-SM20R – length 20"	TS-SM40R – length 40"	TS-SM30R – length 30"	TS-SM60R – length 60"				
TS-SM20R – length 20"	TS-SM40R – length 40"								
TS-SM30R – length 30"	TS-SM60R – length 60"								
	<p>Transfer Set, standard bore, SPIKE/SPIKE, roller clamp</p> <table style="width: 100%; border: none;"> <tr> <td style="border: none;">TS-SS20R – length 20"</td> <td style="border: none;">TS-SS40R – length 40"</td> </tr> <tr> <td style="border: none;">TS-SS30R – length 30"</td> <td style="border: none;">TS-SS60R – length 60"</td> </tr> </table>	TS-SS20R – length 20"	TS-SS40R – length 40"	TS-SS30R – length 30"	TS-SS60R – length 60"				
TS-SS20R – length 20"	TS-SS40R – length 40"								
TS-SS30R – length 30"	TS-SS60R – length 60"								

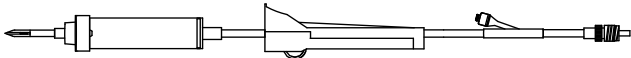

	<p>Transfer Set, standard bore, SPIKE/SPIKE, slide clamp</p> <p><i>TS-SS20S – length 20"</i> <i>TS-SS40S – length 40"</i> <i>TS-SS30S – length 30"</i> <i>TS-SS60S – length 60"</i></p>
	<p>Transfer Set, standard bore, SPIKE/MLL rotating, roller clamp & slide clamp</p> <p><i>TS-SMR20RS – length 20"</i> <i>TS-SMR40RS – length 40"</i> <i>TS-SMR30RS – length 30"</i> <i>TS-SMR60RS – length 60"</i></p>
	<p>Transfer Set, standard bore, SPIKE/ Male Luer Slip, roller clamp</p> <p><i>TS-SMS20R – length 20"</i> <i>TS-SM40R – length 40"</i> <i>TS-SMS30R – length 30"</i> <i>TS-SM60R – length 60"</i></p>
	<p>Pour Spout, for solution transfer, large bore tubing, 6" or 8"</p> <p><i>TS-6PS – length 6"</i> <i>TS-8PS – length 8"</i></p>
	<p>Transfer Set, standard bore, Vented SPIKE/ FLL, on/off clamp</p> <p><i>TS-SF08VP – length 8"</i> <i>TS-SF30VP – length 30"</i> <i>TS-SF15VP – length 15"</i> <i>TS-SF40VP – length 40"</i></p>
	<p>Transfer Set, standard bore, Vented SPIKE/ FLL, roller clamp</p> <p><i>TS-SF08VRC – length 8"</i> <i>TS-SF30VRC – length 30"</i> <i>TS-SF15VRC – length 15"</i> <i>TS-SF40VRC – length 40"</i></p>
	<p>Transfer Set, standard bore, Vented SPIKE/ MLL, on/off clamp</p> <p><i>TS-SM08VP – length 8"</i> <i>TS-SM30VP – length 30"</i> <i>TS-SM15VP – length 15"</i> <i>TS-SM40VP – length 40"</i></p>
	<p>Transfer Set, standard bore, Vented SPIKE/ MLL, roller clamp</p> <p><i>TS-SM08VRC – length 8"</i> <i>TS-SM30VRC – length 30"</i> <i>TS-SM15VRC – length 15"</i> <i>TS-SM40VRC – length 40"</i></p>

Transfer Sets w/ Needleless Luer Activated Valve	
	<p>Transfer Set, standard bore, Vented Spike/ Needleless luer activated valve</p> <p><i>TS-SNV12VF – length 12”</i></p>
Transfer Sets w/ Check Valve	
 <p style="text-align: right;"><i>Check Valve</i></p>	<p>Transfer Set, standard bore, Vented Spike/ Pressure Check Valve</p> <p><i>TS-SCV80VF – length 80”</i></p>
 <p style="text-align: right;"><i>Dual Check Valve</i></p>	<p>Contrast Transfer Set, standard bore, 45”, Vented Spike/ Dual Pressure Check Valve, on/off clamp, for automatic filling of syringes in CT Scan or MRI</p> <p><i>TS-45DCV – length 45”</i></p>
 <p style="text-align: right;"><i>Dual Check Valve w/ rotating MLL</i></p>	<p>Contrast Transfer Set, standard bore, 45”, Vented Spike/ Dual Pressure Check Valve w/rotating MLL, on/off clamp, for automatic filling* of syringes in CT Scan or MRI</p> <p><i>TS-45DCVR – length 45”</i></p>
 <p style="text-align: center;"><i>MLL FLL (Detachable)</i></p> <p style="text-align: right;"><i>Dual Check Valve</i></p>	<p>Transfer Set, standard bore, Detachable Vented Spike/ Dual Pressure Check Valve</p> <p><i>TS-SCVD45VFDT – length 45”</i></p>
Transfer Sets w/ Stopcock	
	<p>Contrast Transfer Set, standard bore, 45”, vented spike, 3 way stopcock with “OFF” Handle & rotating MLL, on/off clamp, for automatic filling of syringes in CT Scan or MRI</p> <p><i>TS-45W3F – length 45”</i></p>
Administration Sets	
	<p>Administration Set, standard bore, 20 drops/ml, vented drip chamber with 15 micron solution filter, 67”, MLL, roller clamp</p> <p><i>AS-67VF – length 67”</i></p>

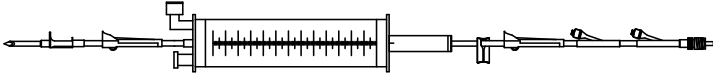
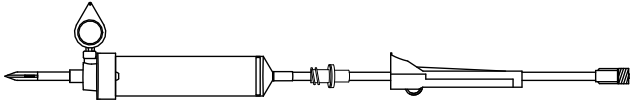
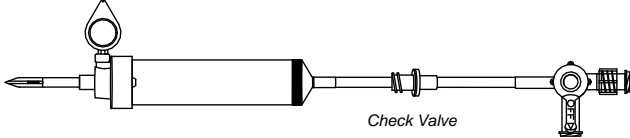
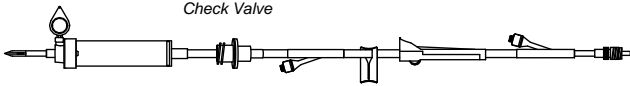
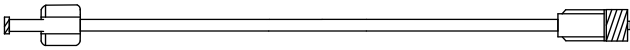
	<p>Administration Set, standard bore, 20 drops/ml, vented drip chamber with 15 micron solution filter, 100", MLL, roller clamp</p> <p>AS-100VF – length 100"</p>
	<p>Administration Set, standard bore, 20 drops/ml, vented drip chamber, 105", catheter connector, roller clamp</p> <p>AS-105VFCC – length 105"</p> <div style="border: 1px solid black; padding: 2px; width: fit-content; margin-left: auto; margin-right: auto;"> <p>AS-xxVFCC (xx is length in inches)</p> </div>
	<p>Administration Set, standard bore, 20 drops/ml, MLL, roller clamp (used as secondary medication set)</p> <p>AS-35 – length 35" AS-50 – length 50"</p> <div style="border: 1px solid black; padding: 2px; width: fit-content; margin-left: auto; margin-right: auto;"> <p>AS-xx (xx is length in inches)</p> </div>
	<p>Administration Set, standard bore, rotating MLL, 20 drops/ml, roller clamp (used as secondary medication set)</p> <p>AS-35R – length 35" AS-50R – length 50"</p> <div style="border: 1px solid black; padding: 2px; width: fit-content; margin-left: auto; margin-right: auto;"> <p>AS-xxR (xx is length in inches)</p> </div>
	<p>Administration Set, standard bore, 20 drops/ml, 82", Y injection site, rotating MLL, roller clamp</p> <p>AS-82Y – length 82"</p> <div style="border: 1px solid black; padding: 2px; width: fit-content; margin-left: auto; margin-right: auto;"> <p>AS-xxY (xx is length in inches)</p> </div>
	<p>Administration Set, standard bore, 20 drops/ml, 82", 2- Y injection sites, rotating MLL, roller clamp</p> <p>AS-82Y2 – length 82"</p> <div style="border: 1px solid black; padding: 2px; width: fit-content; margin-left: auto; margin-right: auto;"> <p>AS-xxY2 (xx is length in inches)</p> </div>
<p>Administration Sets w/ Needleless Luer Activated Valve</p>	
	<p>Administration Set, standard bore, 20 drops/ml, 82", Needleless Y injection site, rotating MLL, roller clamp</p> <p>AS-82NY – length 82"</p> <div style="border: 1px solid black; padding: 2px; width: fit-content; margin-left: auto; margin-right: auto;"> <p>AS-xxNY (xx is length in inches)</p> </div>
	<p>Administration Set, standard bore, 20 drops/ml, 82", Needleless Y injection site, rotating MLL, roller clamp & slide clamp</p> <p>AS-82NYS – length 82"</p> <div style="border: 1px solid black; padding: 2px; width: fit-content; margin-left: auto; margin-right: auto;"> <p>AS-xxNYS (xx is length in inches)</p> </div>

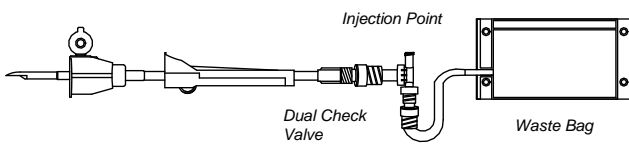
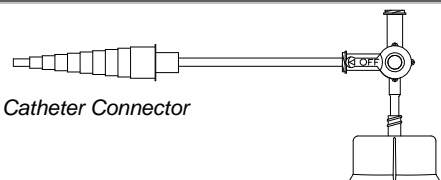
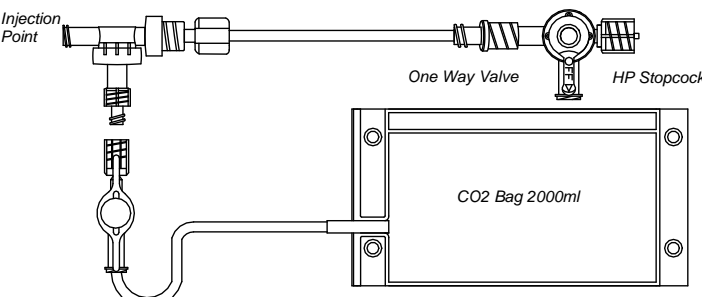
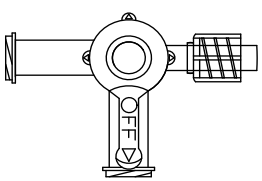
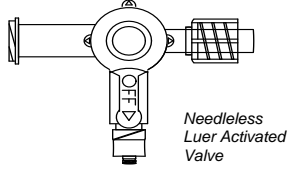
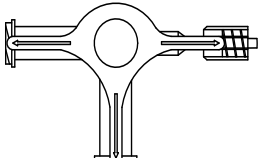
	<p>Administration Set, standard bore, 20 drops/ml, 82", 2 Needleless Y injection sites, rotating MLL, roller clamp</p> <p>AS-82NY2 – length 82"</p> <div style="border: 1px solid black; padding: 5px; width: fit-content; margin-left: auto;"> <p>AS-xxNY2 (xx is length in inches)</p> </div>
	<p>Administration Set, standard bore, 20 drops/ml, 82", 2 Needleless Y injection sites, rotating MLL, roller clamp & slide clamp</p> <p>AS-82NY2S – length 82"</p> <div style="border: 1px solid black; padding: 5px; width: fit-content; margin-left: auto;"> <p>AS-xxNY2S (xx is length in inches)</p> </div>
	<p>Buretrol Administration Set Pediatric, standard bore, 60 drops/ml, 117", 3 Needleless Y injection sites, rotating MLL, roller clamp, slide clamp</p> <p>AS-117NY2BT60 – length 117"</p> <div style="border: 1px solid black; padding: 5px; width: fit-content; margin-left: auto;"> <p>AS-xxNY2 (xx is length in inches)</p> </div>
<p>Administration Sets w/ Check Valve</p>	
 <p style="text-align: center; margin-top: 5px;">Check Valve</p>	<p>Administration Set, standard bore, 20 drops/ml, vented drip chamber, 90", one way gravity check valve, MLL, roller clamp</p> <p>AS-90VCGV – length 90"</p>
<p>Administration Sets w/ Check Valve & Stopcock</p>	
 <p style="text-align: center; margin-top: 5px;">Check Valve</p>	<p>Administration Set, standard bore, 20 drops/ml, vented drip chamber with 15 micron solution filter, 12", one way gravity check valve, 3 way stopcock with FLL output</p> <p>AS-12VFCVGW3F – length 12"</p>
<p>Administration Sets w/ Check Valve & Needleless Luer Activated Valve</p>	
 <p style="text-align: center; margin-top: 5px;">Check Valve</p>	<p>Administration Set, standard bore, 20 drops/ml, vented drip chamber, 110", one way gravity check valve, 2 Needleless Y injection sites, rotating MLL, roller clamp, slide clamp</p> <p>AS-110VCGVNY2 – length 110"</p>
<p>High Pressure Injection Lines</p>	
	<p>Injection Line, PVC, 500-800 psi</p> <p>LI-12 – length 12" LI-36 – length 36" LI-24 – length 24" LI-48 – length 48"</p>

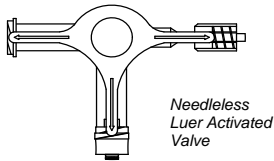
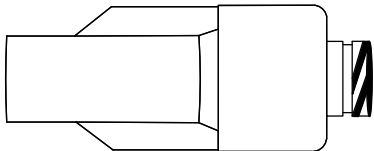
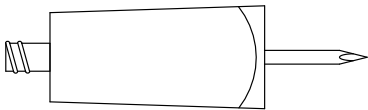
<h3 style="color: red;">Waste Collection Sets</h3>	
 <p style="text-align: center;">Injection Point</p> <p style="text-align: center;">Dual Check Valve</p> <p style="text-align: center;">Waste Bag</p>	<p>Cath Lab Flush & Fill waste bag collection system, with dual check valve, 2000ml waste bag, for syringe injection</p> <p>TS-FF2000</p>
<h3 style="color: red;">Medication Kits</h3>	
 <p style="text-align: center;">Catheter Connector</p>	<p>Medication Kit, 20mm vial</p> <p>MK-1000V20</p>
<h3 style="color: red;">CO2 Angiography Extension Sets</h3>	
 <p style="text-align: center;">Injection Point</p> <p style="text-align: center;">One Way Valve</p> <p style="text-align: center;">HP Stopcock</p> <p style="text-align: center;">CO2 Bag 2000ml</p>	<p>CO2 Angiography Extension Set</p> <p>AES-1000</p>
<h3 style="color: red;">Access Devices</h3>	
<h4 style="color: green;">Stopcocks</h4>	
	<p>3 way Stopcock with "OFF" Handle, rotating MLL</p> <p>SC-W3F</p>
 <p style="text-align: center;">Needleless Luer Activated Valve</p>	<p>3 way Stopcock with "OFF" Handle, rotating MLL, needleless luer activated valve</p> <p>SC-W3FLV</p>
	<p>4 way Stopcock with "T" Handle, rotating MLL</p> <p>SC-W4T</p>

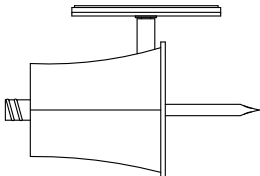
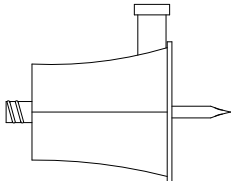
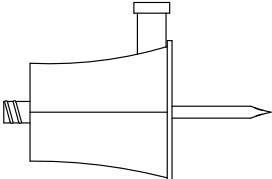
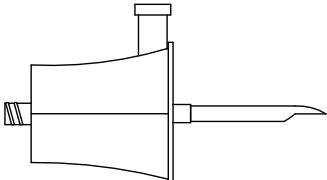
 <p style="text-align: center;"><i>Needleless Luer Activated Valve</i></p>	<p>4 way Stopcock with "T" Handle, rotating MLL, needleless luer activated valve</p> <p>SC-W4TLV</p>
<p>Needleless Luer Activated Valves</p>	
	<p>Needleless Luer Activated Valve</p> <p>TS-NV1</p>
<p>Dispensing Pins</p>	
	<p>Taky/Chemo Spike with 0.2 micron filter, for filling syringes without needles</p> <p>TS-100</p>
	<p>Taky/Chemo Spike with 0.2 micron filter, needleless connector, for filling syringes without needles</p> <p>TS-100NL</p>
	<p>Taky/Chemo Spike with 0.2 micron large surface area hydrophobic filter, for filling syringes without needles</p> <p>TSL-100</p>
	<p>Micro Dispensing Pin, vented with 3 micron hydrophobic filter, for drug vial reconstitution</p> <p>TS-200MC</p>
	<p>Mini Dispensing Pin, vented with 3 micron hydrophobic filter, for drug vial reconstitution</p> <p>TS-200M</p>
	<p>Large Dispensing Pin, vented with 3 micron hydrophobic filter, for drug vial reconstitution</p> <p>TS-200L</p>

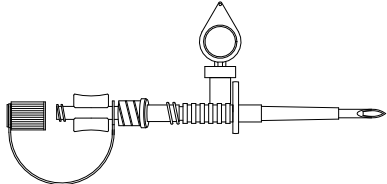
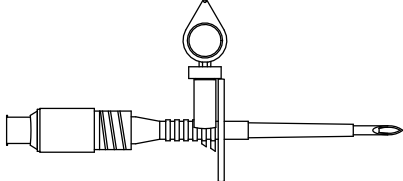
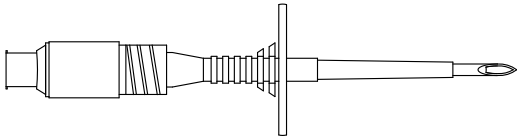
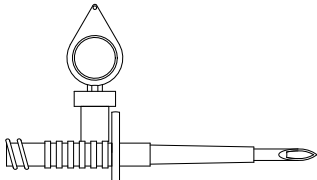
	<p>One Way Fluid Transfer Valve, vented spike with hinged cap, for withdrawal of diluents or injectable medication into syringes</p> <p><i>TS-400</i></p>
	<p>Vented Dispensing Pin, with two way needleless valve</p> <p><i>TS-300VN</i></p>
	<p>Vented Dispensing Pin, with two way needleless valve</p> <p><i>TS-300N</i></p>
	<p>Large Bore Rapid flow Vented Spike, with 3 micron antibacterial hydrophobic air filter, FLL, for use with syringes or other luer lock devices</p> <p><i>TS-500VL</i></p>

Vial Adapters

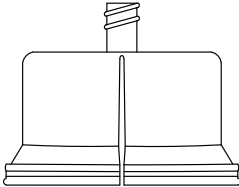
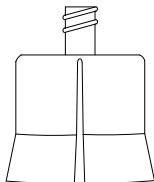
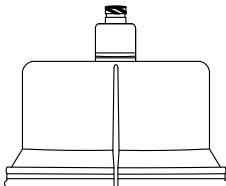
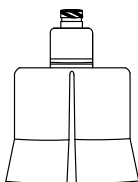
	<p>Vial Adapter, 20mm, with FLL fitting</p> <p><i>TS-620VL</i></p>
	<p>Vial Adapter, 13mm, with FLL fitting</p> <p><i>TS-613VL</i></p>
	<p>Vial Adapter, 20mm, with Needleless Adapter</p> <p><i>TS-620VN</i></p>
	<p>Vial Adapter, 13mm, with Needleless Adapter</p> <p><i>TS-613VN</i></p>

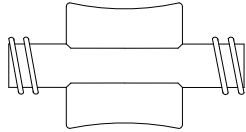
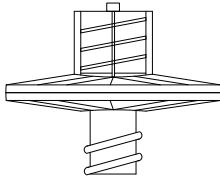
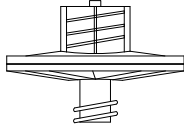
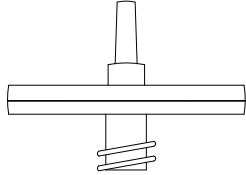
Syringe Coupler	
	Syringe Coupler, FLL/FLL <i>TS-700FF</i>
Syringe Disk Filters	
	Syringe Disk Filter, Hydrophobic, 0.2 micron, 25mm, FLL/MLL <i>TS-800A</i>
	Syringe Disk Filter, Hydrophilic, 0.2 micron, 20mm, FLL/MLL, PES membrane <i>TS-800S20LLPE</i>
	Syringe Disk Filter, Hydrophilic, 0.2 micron, 25mm, FLL/MLS, PES membrane <i>TS-800S25LSPE</i>